

Electrorad Digi-Line

Installation, Operating & Instruction Manual



After Sales Service:

ELECTRORAD UK LTD
T: 0844 479 0055, info@electrorad.co.uk

01.01.2018



Class 1 - 230V - 50 Hz

Contents

1.0	Warnings & Safety Information	03
2.0	General Information	05
3.0	Installation	06
4.0	Maintenance, Repair & Disposal	07
5.0	Waste Disposal According to The WEEE Directive (2002/96/EC)	08
6.0	Warranty	08
7.0	Operating Instructions	08
7.1	Display	08
7.2	Behaviour Indicator	09
7.3	Keyboard	09
8.0	Working Mode Definition	09
8.1	Manual Comfort Mode	09
8.2	Manual Reduced Mode	09
8.3	Frost Protection Mode	09
8.4	Standby Mode	10
8.5	Automatic Mode	10
8.6	How To Set The Time	10
8.7	Programme Selection Mode	11
8.8	Defining a User Programme	11
8.9	Wireless Programmer	14
8.10	Timed Override Mode	15
8.11	Power Settings	15
8.12	Sensor	15
9.0	Key Lock Function	15
10.0	Window Open Function	16
11.0	Parameter's Menu	16
12.0	Technical Characteristics	19
13.0	Troubleshooting & Solution	20
14.0	Preset Programmes	21
15.0	Eco Directive Characteristics	22

1.0 Warnings & Safety Information**SAFETY INFORMATION**

This appliance can be used by children aged from 8 years and above and persons with reduced physical, sensory or mental capabilities or lack of experience and knowledge, if they have been given supervision or instruction concerning use of the appliance in a safe way and understand the hazards involved.

Children shall not play with the appliance.

Cleaning and user maintenance shall not be made by children unless they are older than 8 and supervised.

Keep the appliance and its cord out of reach of children aged less than 8 years.

Children of less than 3 years should be kept away from the unit unless continuously supervised.

Children aged from 3 years and less than 8 years shall only switch on/off the appliance provided that it has been placed or installed in its normal operating position and they have been given supervision or instruction concerning use of the appliance in a safe way and understand the hazards involved.

Children aged from 3 years and less than 8 years shall not plug in, regulate, clean the appliance or perform user maintenance.

1.0 Warnings & Safety Information (cont...)

CAUTION

Some parts of this product can become very hot and cause burns. Particular attention has to be given where children and vulnerable people are present.

 In order to avoid overheating, do not cover the radiator. "Do not cover" means that the radiator must not be used for drying clothes, for example, by placing them directly on the radiator.

IMPORTANT SAFETY INSTRUCTIONS!

Before starting work disconnect power supply!

All installation work and wiring work related to the radiators, thermostats and programmers must be carried out only when de-energised.

The appliance should be commissioned by qualified professionals only.

Make sure to adhere to valid safety regulations.

Any repairs or maintenance within the warranty period should be carried out only by approved service engineers confirmed by Electrorad UK Ltd.

For the correct installation of radiators it is essential that the fixing of the radiator is carried out in such a way that it is suitable for intended use AND predictable misuse. A number of elements need to be taken into consideration including the fixing method used to secure the radiator to the wall, the type and condition of the wall itself, and any additional potential forces or weights, prior to finalising installation. **IN ALL CASES IT IS STRONGLY RECOMMENDED THAT A SUITABLY QUALIFIED PROFESSIONAL INSTALLER OR SIMILAR TRADESPERSON CARRIES OUT THE INSTALLATION.**

PLEASE NOTE: The fixing materials provided are only intended for installation on walls made of solid wood, bricks, concrete or on timber-frame stud walls where the fixing is into the timber. All walls being considered should have no more than a maximum of 3mm wall finishing. For walls made of other materials, for example hollow bricks, please consult your installer and/or specialist supplier. **ONCE AGAIN, IF YOU ARE UNSURE, IT IS STRONGLY RECOMMENDED THAT A SUITABLY QUALIFIED PROFESSIONAL INSTALLER OR SIMILAR TRADESPERSON CARRIES OUT THE INSTALLATION.**

The radiator is equipped with an overheat protection that cannot be reset (melt fuse). This overheat protection disconnects the current if the radiator becomes too hot (e.g. when covered).

If the supply cord is damaged, it must be replaced by the manufacturer, his service agent or similar qualified persons in order to avoid a hazard.

1.0 Warnings & Safety Information (cont...)

The radiator is filled with an exact amount of environmental friendly vegetable oil. Any repairs that require the radiator to be opened shall therefore only be carried out by the

manufacturer or his approved agent. Please contact Electrorad UK Ltd in case of leakage.

2.0 General Information

- The appliance is a sealed electric radiator designed for fixed wall mounted installation.
- The radiator conforms to the standards EN 60 335-1 and EN 60 335-2-30.
- The radiator is class 1 and splash resistant (IP44).
- The radiator complies with the European Directive 2004/108/EC (CE Marking on all radiators).
- The radiator is supplied complete with power cable* and wall brackets.
- *A restricted range of radiators come with a 3 pin plug.

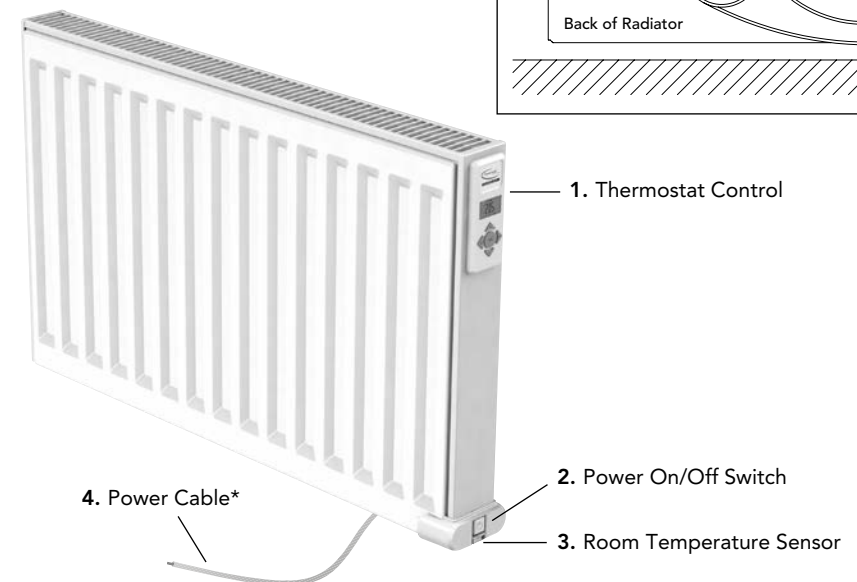
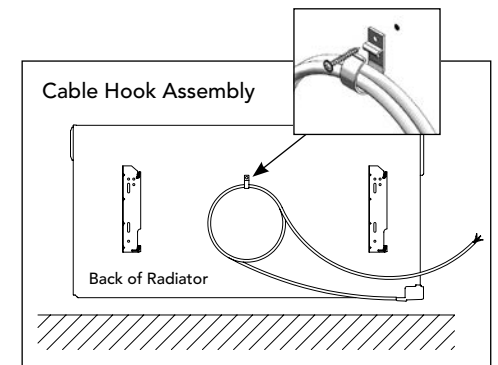

3.0 Installation

POSITIONING

- The radiator must be positioned horizontally, the right way up on the wall in order for it to function correctly. Never switch the radiator on in any other position as this will damage the electrical element.
- The radiator must be positioned according to the applicable standards and the minimum distances as specified in figure 1 should be carefully observed.
- The radiator must not be located underneath an electric socket.

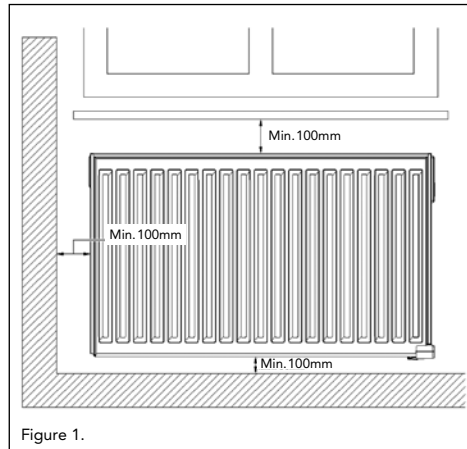

Figure 1.

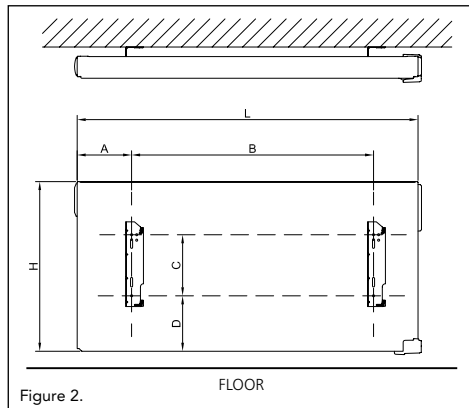

Figure 2.

- This product is splash resistant with an IP44 rating. This must be considered when installing in a location containing a bath or shower, as defined by BS 7671.
- The radiator may be positioned in zone 2 (figure 4) of the bathroom, in so far as no operating controls (button, switch, etc.) are in reach of persons in the bath or under the shower.
- **NB: If the radiator is supplied with a 3 pin plug, then this should NOT be installed in any bathroom zone.**

FIXING

- Mark out the distance between the brackets and the positions for the screw holes as shown in figure 2 and the dimension tables at the top of page 7, and ensure the safety clips are used (see figure 3).

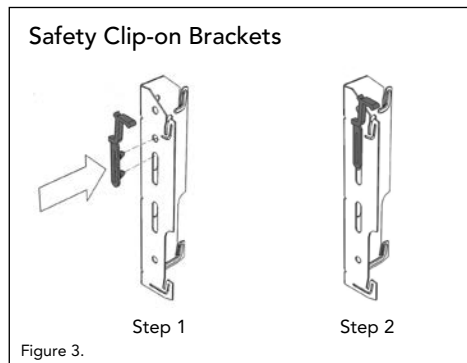

Figure 3.

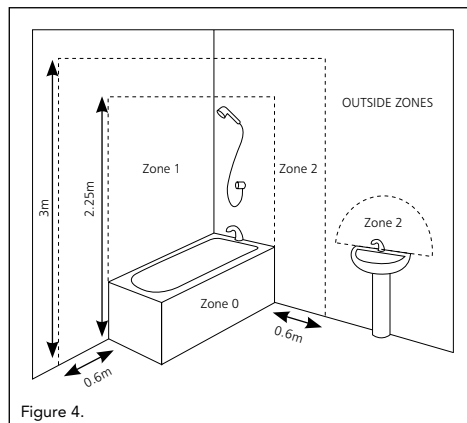

Figure 4.

3.0 Installation (cont...)

Electrorad Digi-Line Single Panel (refer to figure 2)

Height (mm)	300	500	Length (mm)	400	550	800	1050	1100	1300	1500
C	135	205	A (min)	135	135	135	135	135	135	135
D	90	163	A (max)	160	160	160	160	160	160	160
			B (min)	101	254	508	762	812	1016	1219
			B (max)	152	305	558	812	863	1066	1270

Electrorad Digi-Line Double Panel (refer to figure 2)

Height (mm)	300	500	Length (mm)	400	500	650	800	950	1000	1250	1300	1600	2000
C	135	205	A	160	160	160	160	160	160	160	160	160	160
D	90	163	B	101	203	355	508	660	711	965	1016	1320	1727

CONNECTION

- The electrical installation must comply with the local or national regulations.
- The radiator must be connected to the electrical supply, using a switched fused spur with 3mm separation on all poles.
- If the radiator is installed in a bathroom or shower room, it must be protected with a residual current device (RCD) with a rated residual current not exceeding 30 mA.

Optional Extras

RF Programmer + Touch E3

Electrorad Digi-Line radiators can be used as a stand alone radiator. The radiator has a built in radio frequency receiver which can be used with an RF Programmer or Touch E3. Please ask for more details.



4.0 Maintenance, Repair & Disposal

- Use only a damp cloth for cleaning and wiping of the radiator which should be switched off at this time.
- When scrapping the radiator, follow the regulations concerning the disposal of oil.

5.0 Waste Disposal According to The WEEE Directive (2012/19/EU)



Waste disposal according to the WEEE Directive (2012/19/EU). The symbol on the product label indicates that the product may not be handled as domestic waste, but must be sorted separately. When it reaches the end of its useful life, it shall be returned to a collection facility for electrical and electronic products. By returning the

product, you will help to prevent possible negative effects on the environment and health to which the product can contribute if it is disposed of as ordinary domestic waste. For information about recycling and collection facilities, you should contact your local authority/municipality or refuse collection service or the business from which you purchased the product. Applicable to countries where this Directive has been adopted.

WEEE NO: WEE/HD0506VZ

6.0 Warranty

The product is covered by a 10 years warranty except for the electrical and electronic components that are covered by a 2 years warranty.



7.0 Operating Instructions

The electronic thermostat has an LCD display specially designed for the regulation of the electrical radiator. It will optimise energy consumption and increase comfort levels.

Features:

- Display with backlight
- Wireless RF programmer options (see separate instructions)
- Timed override function.

Note: The radiator has a soft start feature built into the control software such that full power is not applied at power up, whether it is the first time the radiator is switched on or whenever the radiator loses power by switching it off. The software gradually increases power from zero to full power over a 20 minute period.

7.1 Display

1. Operating mode menu (active mode is framed).
2. Front panel temperature limit, Parameters number if icon "3" is displayed or selected programme number.
3. Installation parameter indicator.
4. "Key lock" function indicator.
5. "Room temperature" indicator.
6. Display zone for temperatures, parameters, or time.
7. "Heating demand" indicator.
8. "Behaviour" indicator or programme information bar.
9. "Mode" indicator in "Automatic" mode.
10. Day of week indicator.
11. "RF connection" indicator (with RF clock or Touch E3).
12. Hand icon.
13. "Window open" function indicator.

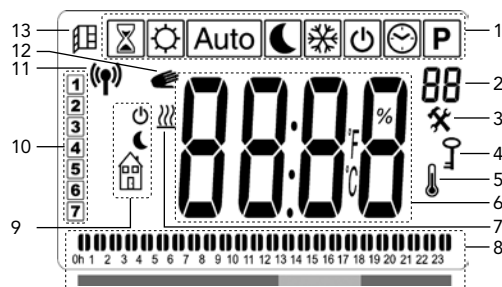

7.2 Behaviour Indicator

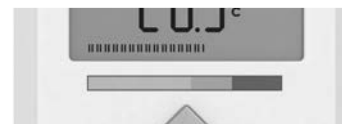

This is the bar at the bottom of the LCD display that gives a visual indication of how much energy the current temperature setting is using i.e.

- red = high
- orange = medium
- green = low energy consumption

7.3 Keyboard



Keys:

- < = Left Navigation Key
- > = Right Navigation Key
- + = Plus Key
- = Minus Key
- OK = Validation Key

As you increase the temperature setting, the behaviour indicator "bar", in section 8 of the LCD display, will increase in length.

The opposite applies when decreasing the temperature setting.

NOTE: The behaviour indicator is replaced by the programme information bar when in Automatic mode.

8.0 Working Mode Definition



How to change the working mode:

- Use the navigation keys left (<) or right (>) to display the working mode line.
- Move the frame cursor on the desired working mode and press (OK) to enter in the operating mode you have chosen.

8.1 Manual Comfort Mode



Manual working mode, the comfort setting temperature will be followed all the time. By pressing the (+) or (-) keys, the comfort setting temperature starts to blink and can be adjusted.

This temperature will also be used when following the weekly schedule on the programmer (if applicable).

This temperature will also be used when following the weekly schedule on the programmer (if applicable).

8.2 Manual Reduced Mode



Manual working mode, the reduced setting temperature will be followed all the time. By pressing the (+) or (-) keys, the reduced setting temperature starts to blink and can be adjusted.

The reduced temperature is intended to be used during the night or for short periods of time when not in the room/property.

This temperature will also be used when following the weekly schedule on the programmer (if applicable).

This temperature will also be used when following the weekly schedule on the programmer (if applicable).

8.3 Frost Protection Mode



Use this mode if you want to protect your system against freezing when leaving the property for extended periods.

By pressing (+) or (-) keys, the reduced setting temperature starts to blink and can be adjusted.

8.4 Standby Mode



- In this mode the radiator is switched off.
- The radiator will no longer receive signals from the RF programmer or Touch E3 (if applicable).
- At any time, press any key to view the measured room temperature.
- **Attention:** In this mode, your radiators may freeze in very cold weather. Please be aware, if there is no heating in your property then your pipes could freeze. For protection of the product and property in very low temperatures, we recommend the 'frost protection' mode is used.

8.5 Automatic Mode



This mode is only to be used when paired to the timings/settings of the RF programmer or Touch E3 (if applicable).



8.6 How To Set The Time

- When first powered on, the digital control enters into time setting mode.
- Time setting mode can also be entered into by pressing the "OK" key for 3 seconds while in any of the heating modes.

NOTE: If power is lost, from a power cut or the product is switched off, even just for a few seconds, the time and day setting will be lost.

NOTE: If connected to an RF programmer or the Touch E3, it is not possible to enter into the time setting mode.



- The hour value will blink. Adjust the hour value by pressing the "+" or "-" keys, then confirm by pressing the "OK" key.



- The minute value will blink. Adjust the minute value by pressing the "+" or "-" keys, then confirm by pressing the "OK" key.

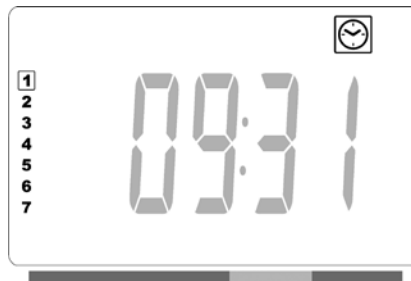

8.6 How To Set The Time (cont...)

- The day values, in section 10 of the LCD display, will blink. Adjust the day value by pressing the "+" or "-" keys, then confirm by pressing the "OK" key.
- The "Comfort" mode or previously selected operating mode screen will appear.

NOTE: If the time is not set within 60 seconds, the "Comfort" or previously selected operating mode screen will appear.

8.7 Programme Selection Mode



NOTE: If connected to an RF programmer or the Touch E3, it is not possible to enter into the programme selection mode as the clock icon is made unavailable.

Selecting a Programme

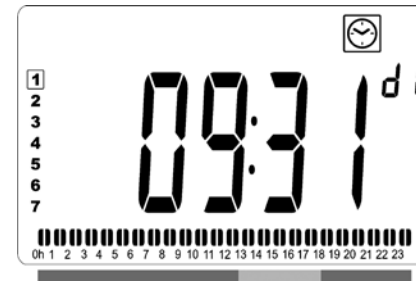

- Use the "+" or "-" keys to select one of the preset programmes, d1 to d9 (see page 21), or one of the user definable programmes, U1 to U4. The programme number will blink. The programme sequence for the current day is displayed along the bottom of the screen. Press the "OK" key to confirm the programme to be followed.
- When confirmed, the control will return to Automatic.

8.8 Defining a User Programme

NOTE: Once saved, the user defined programmes are not lost in the event of a power cut. However, the time will reset to 00:00 and day 1 when the power returns, if not set, so the product may not heat at the expected times.

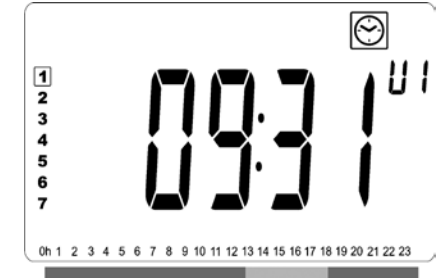

- Use the "+" or "-" keys to select a user definable programme, U1 to U4, to be modified, then press and hold the "OK" key for 3 seconds.

NOTE: If a user defined programme has already been created and saved, it will be overwritten when the newly defined user programme is saved.

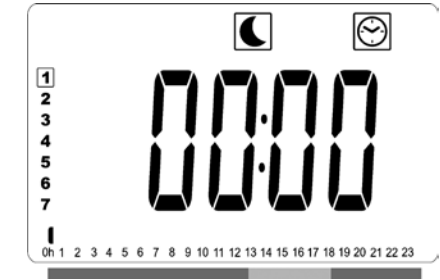

- The above screen will be shown, where the moon symbol, the time value 00:00, and the time segment in the programme information bar along the bottom of the screen will blink continuously.

8.8 Defining a User Programme (cont...)

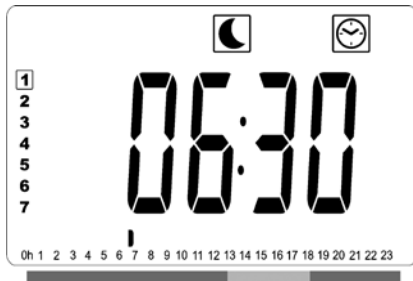

- Use the "+" or "-" keys to adjust the time at which the first Reduced period will end.
- As the time indexes, the blinking segment on the programme information bar will move horizontally along the time scale according to the time value.

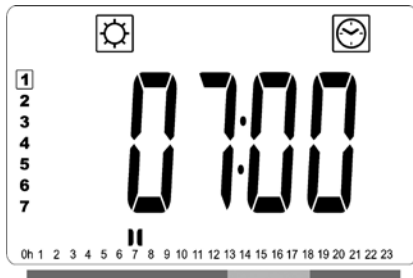

- Press the "OK" key to confirm the time at which the mode will change over from Reduced to Comfort. The symbol ☀ will start to blink instead of the 🌙 symbol, signifying the start of this Comfort period.

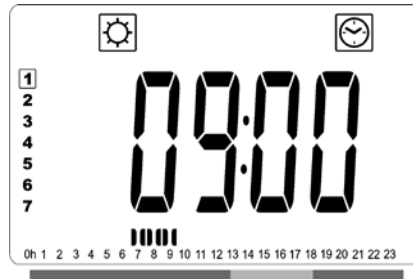

- Use the "+" and "-" keys to adjust the time at which the first Comfort period will end. The segments in the programme information bar will populate to show the Comfort period.



- Press the "OK" key to confirm the time at which the mode will change over from Comfort to Reduced. The symbol 🌙 will start to blink instead of the ☀ symbol, signifying the start of this Reduced period.

8.8 Defining a User Programme (cont...)

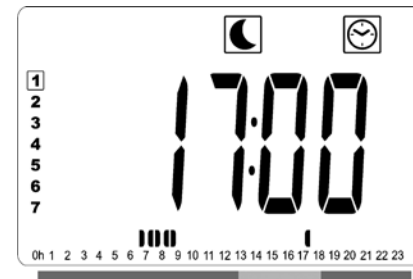

- Use the "+" or "-" keys to adjust the time at which this Reduced period will end.

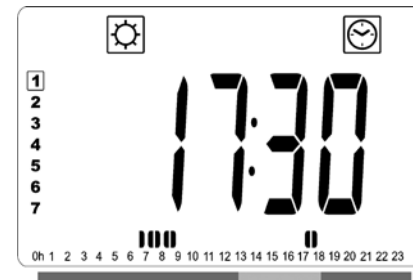

- Press the "OK" key to confirm the time at which the mode will change over from Reduced to Comfort. The symbol ☀ will start to blink instead of the 🌙 symbol, signifying the start of this Comfort period.

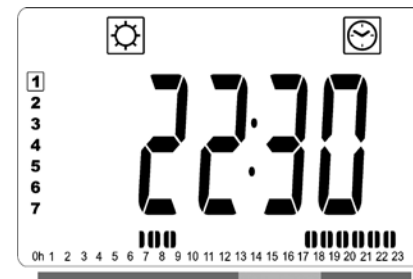

- Use the "+" and "-" keys to adjust the time at which this Reduced period will end. The segments in the programme information bar will populate to show the Comfort period.

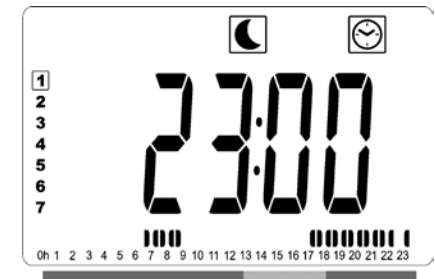

- Press the "OK" key to confirm the time at which the mode will change over from Comfort to Reduced. The symbol 🌙 will start to blink instead of the ☀ symbol, signifying the start of this Reduced period.
- If more than two Comfort periods are required, repeat the previous steps.



- When all Comfort periods have been defined, use the "+" key to advance beyond the time "23:30". The above screen will then be shown, asking if the programme that has just been defined for that day is to be copied to the next day.
- To copy the programme onto the next day, press the "OK" key. Press the "OK" key for any further days the programme is to be copied over to.

8.8 Defining a User Programme (cont...)

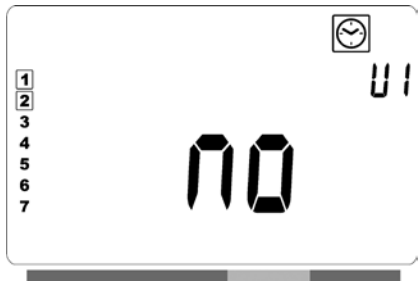

- If a different programme is to be defined for the next day, press the "+" or "-" key until the word "no" is displayed. Press the "OK" key to confirm.
- When all of the days have been defined, the word "SAVE" will be displayed. To save the programme, press the "OK" key to confirm.
- If the programme is not to be saved, so that any previously user defined programme is not overwritten, press the left "◀" arrow key. The screen will revert back to the Programme Selection screen.

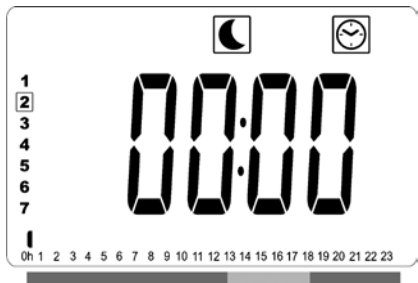

- The day number will increment to the next day and the time will be set back to "00:00".

8.9 Wireless Programmer



If a Wireless programmer is paired, the thermostat will follow the set programme.

A Wireless clock signal will be shown by the flashing symbol.

- ⚙ The thermostat will follow the comfort temperature value.
- ☾ The thermostat will follow the reduced temperature value previously set.
- ❄ The thermostat will follow the frost protection setting temperature.
- ⏻ The thermostat is turned OFF.
Careful: In this mode, the pipes in the property can freeze.

8.10 Timed Override Mode



The Timer mode allows the set temperature and heating period to be adjusted for a specific time.

This function should only be used to override the programmed settings.

- First adjust the desired setting temperature with (+) or (-). Press (OK) to start the function (default value 19°C).

- Then, adjust the duration in hours "H" if below 24H, then in day "D" with (+) or (-). Press (OK) to validate (adjustable 1 Hour to 44 days).

The ⌚ logo will blink and the number of hours /days left is displayed until the end of the period.

💡 To stop the Timer function before the end, set the duration period to "no" with the (-) key.

8.11 Power Settings



To set the power of the front heating panel choose between:

Setting*	Surface Temperature	Single Panel	Double Panel
1	~60°C Max	~0.55	~0.80
2	~75°C Max	~0.70	~0.90
3	~90°C Max	1	1

When considering the permanent use of the radiator at 60°C or 75°C maximum, the correction factor from the table (right) should be applied for the output.

E.g. A 1000 Watt single panel programmed for a maximum surface temperature of 75°C will deliver maximum 700 Watts. A 1000 Watt double panel programmed for a maximum surface temperature of 60°C will deliver maximum 800 Watts. These values should be considered when selecting the number and type of panels to cover the calculated heat losses.

*Please refer to Section 7.1 Display, point 2 as to where this will be shown on the display.

8.12 Sensor

Please Note: The thermostat sensor is located at the bottom of the radiator and will only read the room temperature and not the actual temperature from the radiator.

9.0 Key Lock Function



Use this function to prevent any changes of the settings (in a child's room, public area...etc.).

- To activate the Key Lock function, first press and maintain the validation key (OK) and then press simultaneously on the left (<) and right (>) key.

- The ⏻ logo will be displayed on the screen.
- Repeat the same procedure to unlock the keyboard.



Note: The Key Lock function is available in all operating modes.

10.0 Window Open Function



The radiator is equipped with a "window open" function. This function will switch the radiator from any active mode to "Frost Protection" mode when an open window is detected (room temperature drops by more than 2°C in less than 30 minutes). The window open icon will start to blink and continue to blink as long as the

function is active. To return to the previous or automatic mode push the "OK" key twice. If no manual intervention has been detected, the radiator will check automatically, after 30 minutes, if the room temperature has increased (window has been closed) and if so, return automatically to the previous or automatic operating mode.

11.0 Parameter's Menu

Your thermostat has a parameter's menu. In order to enter this menu, press and hold the validation key (OK) for 6 seconds. At 3 seconds, the clock setting screen will appear, but continue to hold the 'OK' key for the whole 6 second period until, in section 3 of the LCD display, and 'rFi' is displayed on the screen. Then the parameter menu will appear and the first menu screen will be displayed (see opposite).

Parameters can be selected using the navigation keys (<) or (>). Once the parameter is chosen, toggle the value with the (OK)

key, modify it with (+) or (-) and confirm your adjustment with (OK).

To leave the parameter menu, choose the parameter « End » and press (OK).

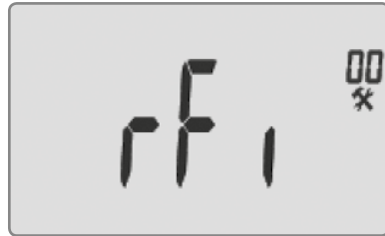



N°	Default value & other possibilities
00	<p>rF i: Wireless Radio initialization (pairing)</p> <p>Press "OK" to enter this initialization sequence. Select with "+" or "-" the radio communication type and confirm by pressing the "OK" key:</p> <ul style="list-style-type: none"> • rF.un: unidirectional communication - the digital thermostat only receives orders from an RF programmer. • rF.bi: bidirectional communication with an Touch E3. The digital thermostat communicates state and power consumptions to the Touch E3. <p>Then the backlight will switch off and the digits will cycle showing that the digital thermostat is waiting for a radio link signal from an RF programmer or Touch E3 to be received (press "◀" to cancel radio initialization). When the radio link signal is received, pairing is saved, then it will return to Auto mode.</p> <p>NOTE: Pairing between the devices can be very quick where cycling of the digits may not be seen.</p>

11.0 Parameter's Menu (cont...)

N°	Default value & other possibilities
01	<p>dEG : Type of Degrees Displayed</p> <p>Press "OK" to enter this parameter. Select with "+" or "-" and confirm by pressing the "OK" key:</p> <p>°C = Celsius °F = Fahrenheit</p>
02	<p>__._ : Calibration of the Internal Probe</p> <p>The calibration must be done after 1 day working with the same setting temperature in accordance with the following description:</p> <p>Put a thermometer in the room at 1.5m distance from the floor (like the thermostat) and check the real temperature in the room after 1 hour.</p> <p>When you enter the calibration parameter screen the actual temperature value is displayed.</p> <p>To enter the value shown on the thermometer, use the "-" or "+" keys to enter the real value. At this point the hand icon, in section 12 of the LCD display, will be displayed and the value will blink. Press the "OK" key to confirm and save. If you need to erase a calibration already saved use the "-" or "+" keys to alter the value, even just by 1°C, then press the left "◀" navigation key. The hand symbol will disappear and the factory calibrated temperature reading will be displayed.</p> <p>NOTE: Only the heating elements (including slave radiators) managed by the thermostat must be used during the calibration process. Do not have a secondary heat source in the same room for a period of 24 hours before hand.</p>
03	<p>SrC : Sequential Control of Front and Back Panel</p> <p>NOTE: This feature is only applicable to double panel radiators.</p> <p>Press "OK" to enter this parameter. Select with "+" or "-" and confirm by pressing the "OK" key:</p> <p>no: Sequential control function disabled (Front=Back).</p> <p>YES: Sequential control function enabled. Heat output is prioritised to the front panel to maximise radiant heat. Thus, the "back" heating element will activate if the temperature is one degree below the set point, acting as a booster.</p> <p>NOTE: The rear panel temperature can be considerably lower than the front panel when this function is enabled.</p>

11.0 Parameter's Menu (cont...)

N°	Default value & other possibilities
04	<p>Software Version</p> <p>Displays the software version of the digital thermostat.</p>
05	<p>Wind : Open Window Detection </p> <p>(the text "Wind" is displayed)</p> <p>Press the "OK" key to enter this parameter. Select with "+" or "-" and confirm by oppressing the "OK" key:</p> <p>no: open window detection function disabled.</p> <p>YES: open window detection function enabled. The , in section 13 of the LCD display, is constantly displayed. This function will switch the radiator from any active mode to "Frost Protection" mode when an open window is detected (room temperature drops by more than 2°C in less than 30 minutes). The open window icon  will start to blink, and continue to blink as long as the function is active.</p> <p>To return to the previous or automatic mode, press the "OK" key twice. If no manual intervention has been detected, the radiator will check automatically if the room temperature has increased (window has been closed) and if so, return automatically to the previous or automatic operation mode.</p>
06	<p>ItCS : Adaptive Start</p> <p>Press the "OK" key to enter this parameter. Select with "+" or "-" and confirm by oppressing the "OK" key:</p> <p>no: adaptive start function disabled. Heating up to reach the Comfort set temperature will start at the programmed time.</p> <p>YES: adaptive start function enabled. Heating up will start at the predicted optimal time to reach the Comfort set temperature at the programmed time.</p> <p>NOTE: Heating start times will vary for each heating period when this function is enabled.</p>
07	<p>SLA : Master/Slave Set-up</p> <p>Set this function to 'no' for normal operation.</p>

11.0 Parameter's Menu (cont...)

N°	Default value & other possibilities
08	<p>CLr : Factory Setting</p> <p>Press and hold the "OK" key for 6 seconds to reset Set point temperatures and all user parameters in this menu to factory default settings.</p> <p>NOTE: Pairing with the RF programmer or Touch E3 will be lost.</p> <p>The screen will go blank, the LCD screen will illuminate and all segments will be displayed for a few seconds, then disappear, before displaying the software version. The product will then enter into time setting mode. If the time is not set within 60 seconds, the time will be set to the default values of 00:00 and Day 1. The "Comfort" mode screen will appear.</p>
09	<p>End : Exit the Parameter Menu</p> <p>Press the "OK" key to exit installation parameter menu and return to normal operation.</p>

12.0 Technical Characteristics

Environmental:	
Operating temperature	-10°C - +50°C
Shipping and storage temperature	-30°C to +70°C
Electrical protection	Class 1 - IP44
Setting temperature range:	
Comfort	Between 5.5°C and 30°C must be higher than reduced mode setting
Reduced	Between 5°C and 19°C must be less than comfort mode setting
Frost Protection	Between 0.5°C and 10°C
Power Supply	230Vac +/- 10% 50Hz
Norms and directives:	
Your thermostat was designed in accordance with the following European norms and directives:	ECO Directive 2009/125/EC 2006/95/CE - Low Voltage 2004/108/CE - EMC EN60335-1 - Heaters R&TTE 1999/5/CE - RF 2002/95/CE - RoHS

15.0 Eco Directive Characteristics

Model identifier(s): DExxxxxx or DExxxxxxP where "x" may be any character.

Item	Symbol	Value	Unit
Heat Output			
Nominal heat output where "xxxxxx" = 30SC40	P_{nom}	0.25	kW
Nominal heat output where "xxxxxx" = 30SC80, 50SC55, 30DX50, or 50DX40	P_{nom}	0.50	kW
Nominal heat output where "xxxxxx" = 30SC110, 50SC80, 30DX80, or 50DX50	P_{nom}	0.75	kW
Nominal heat output where "xxxxxx" = 30SC150, 50SC105, 30DX100, or 50DX65	P_{nom}	1.00	kW
Nominal heat output where "xxxxxx" = 50SC130, 30DX130, or 50DX80	P_{nom}	1.25	kW
Nominal heat output where "xxxxxx" = 30DX160 or 50DX95	P_{nom}	1.50	kW
Nominal heat output where "xxxxxx" = 30DX200 or 50DX125	P_{nom}	2.00	kW
Minimum heat output (indicative)	P_{min}	N.A.	kW
Nominal heat output where "xxxxxx" = 30SC40	$P_{max,c}$	0.25	kW
Nominal heat output where "xxxxxx" = 30SC80, 50SC55, 30DX50, or 50DX40	$P_{max,c}$	0.50	kW
Nominal heat output where "xxxxxx" = 30SC110, 50SC80, 30DX80, or 50DX50	$P_{max,c}$	0.75	kW
Nominal heat output where "xxxxxx" = 30SC150, 50SC105, 30DX100, or 50DX65	$P_{max,c}$	1.00	kW
Nominal heat output where "xxxxxx" = 50SC130, 30DX130, or 50DX80	$P_{max,c}$	1.25	kW
Nominal heat output where "xxxxxx" = 30DX160 or 50DX95	$P_{max,c}$	1.50	kW
Nominal heat output where "xxxxxx" = 30DX200 or 50DX125	$P_{max,c}$	2.00	kW
Auxiliary electricity consumption			
At nominal heat output	El_{max}	0.00	kW
At minimum heat output	El_{min}	N.A.	kW
In standby mode	El_{SB}	<0.001	kW

15.0 Eco Directive Characteristics (cont...)

Item	Unit
Type of heat output, for electric storage local space heaters only	
Manual heat charge control with integrated thermostat	N.A.
Manual heat charge control with room and/or outdoor temperature feedback	N.A.
Electronic heat charge control with room and/or outdoor temperature feedback	N.A.
Fan assisted heat output	N.A.
Type of heat output/room temperature control	
Single stage heat output and no room temperature control	No
Two or more manual stages, no room temperature control	No
With mechanic thermostat room temperature control	No
With electronic room temperature control	No
Electronic room temperature control plus day timer	No
Electronic room temperature control plus week timer	Yes
Other control options	
Room temperature control, with presence detection	No
Room temperature control, with open window detection	Yes
With distance control	Yes
With adaptive start control	Yes
With working time limitation	No
With black bulb sensor	No