

System pro M compact® Miniature Circuit Breaker S 200/S 200 M



2GDC0021023S0012



2GDC0021038S0012

The miniature circuit breakers of the System pro M compact® series S 200 and S 200 M provide state-of-the-art safety and comfort. They stand out due to their high performance and the wide range of accessories and approvals.

Features

- Clear contact position indication in red/green (“real CPI”)
- Unique, patented twin terminal with captive screws and an increased opening for cables up to max. 35 mm², finger-proof (IP20)
- Busbar slot in the back for best visibility during installation
- High performance at an increased rated voltage for marine and industrial applications: 10 kA/15 kA at $U_g = 440$ V AC acc. to IEC/EN 60947-2
- Individual product identification code
- Approved acc. to IEC/EN 60898-1, IEC/EN 60947-2 and UL 1077/CSA 22.2 No. 235 for global use

Miniature Circuit Breaker S 200/S 200 M

Technical data

	S 200	S 200 M
General Data		
Standards	IEC/EN 60898-1, IEC/EN 60947-2 UL 1077	IEC/EN 60898-1, IEC/EN 60947-2 UL 1077, CSA 22.2 No. 235
Poles	1P, 2P, 3P, 4P, 1P+N, 3P+N	
Tripping Characteristics	B, C, D, K, Z	
Rated current I_n	0.5 up to 63 A	
Rated frequency	50/60 Hz	
Rated insulation voltage U_i	250 V AC (phase to ground), 500 V AC (phase to phase)	
Overvoltage Category	III	
Pollution Degree	3	
IEC/EN 60898-1		
Rated operational voltage U_n	1P: 230/400 V AC; 1P+N: 230 V AC; 2P, 3P, 4P: 400 V AC; 3P+N: 400 V AC	
Max. power frequency recovery voltage U_{max}	1P: 253 V AC; 1P+N: 253 V AC; 2P, 3P, 4P: 440 V AC; 3P+N: 440 V AC; 1P: 72 V DC; 2P: 125 V DC	
Min. operating voltage	12 V AC, 12 V DC	
Rated short-circuit capacity I_{cn}	6 kA	10 kA
Energy limiting class (B, C up to 40 A)	3	
Rated impulse withstand voltage U_{imp} (1.2/50 μ s)	4 kV (test voltage 6.2 kV at sea level, 5 kV at 2,000 m)	
Dielectric test voltage	2.0 kV (50/60 Hz, 1 min)	
Reference temperature for tripping characteristics	B, C, D: 30 °C	
Electrical endurance	$I_n < 32$ A: 20,000 ops. (AC), 1,000 ops. (DC); one cycle 2 s - ON, 13 s - OFF $I_n \geq 32$ A: 10,000 ops. (AC), 1,000 ops. (DC); one cycle 2 s - ON, 28 s - OFF	
IEC/EN 60947-2		
Rated operational voltage U_e	1P: 230 V AC; 1P+N: 230 V AC; 2P, 3P, 4P: 440 V AC; 3P+N: 440 V AC	
Max. power frequency recovery voltage U_{max}	1P: 253 V AC; 1P+N: 253 V AC; 2P, 3P, 4P: 462 V AC; 3P+N: 462 V AC; 1P: 72 V DC; 2P: 125 V DC	
Min. operating voltage	12 V AC, 12 V DC	
Rated ultimate short-circuit breaking capacity I_{cu}	10 kA	15 kA
Rated service short-circuit breaking capacity I_{cs}	7.5 kA	≤ 40 A: 11.25 kA 50, 63 A: 7.5 kA
Rated impulse withstand voltage U_{imp} (1.2/50 μ s)	4 kV (test voltage 6.2 kV at sea level, 5 kV at 2,000 m)	
Dielectric test voltage	2.0 kV (50/60 Hz, 1 min)	
Reference temperature for tripping characteristics	B, C, D: 55 °C; K, Z: 20 °C	
Electrical endurance	$I_n < 32$ A: 20,000 ops. (AC), 1,000 ops. (DC); one cycle 2 s - ON, 13 s - OFF $I_n \geq 32$ A: 10,000 ops. (AC), 1,000 ops. (DC); one cycle 2 s - ON, 28 s - OFF	
UL/CSA		
Rated voltage	1P: 277 V AC, 60 V DC 2...4P: 480 Y/277 V AC, 110 V DC	1P: 277 V AC, 60 V DC 2...4P: 480 Y/277 V AC, 125 V DC
Rated interrupting capacity	6 kA (AC), 10 kA (DC)	
Application	Suppl. prot. for general use. Application Codes: TC2, OLO, SC: U1	
Reference temperature for tripping characteristic	B, C, D, K, Z: 25 °C	
Electrical endurance	6,000 ops. (AC), 6,000 ops. (DC); one cycle 1 s - ON, 9 s - OFF	
Mechanical data		
Housing	Insulation group II, RAL 7035	Insulation group I, RAL 7035
Toggle	Insulation group II, black, sealable	
Contact position indication	Marking on toggle (I ON/OFF), Real CPI (red ON/green OFF)	
Protection degree acc. to EN 60529	IP20 ¹⁾ , IP40 in enclosure with cover	
Mechanical endurance	20,000 ops.	
Shock resistance acc. to IEC/EN 60068-2-27	25 g, 2 shocks, 13 ms	
Vibration resistance acc. to IEC/EN 60068-2-6	5 g, 20 cycles at 5...150...5 Hz with load 0.8 I_n	
Environmental conditions acc. to IEC/EN 60068-2-30	28 cycles with 55 °C/90-96 % and 25 °C/95-100 %	
Ambient temperature	-25 ... +55 °C	
Storage temperature	-40 ... +70 °C	

¹⁾ Also fulfilling the requirements acc. to the protection degree IPXXB

Miniature Circuit Breaker S 200/S 200 M

Technical data and tripping characteristics

	S 200	S 200 M
Installation		
Terminal	Failsafe bi-directional cylinder-lift terminal	
Cross-section of conductors (top/bottom)	solid, stranded: 35 mm ² / 35 mm ² flexible: 25 mm ² / 25 mm ²	
Cross-section of busbars (top/bottom)	14 – 4 AWG ¹⁾ 10 mm ² / 10 mm ² 14 – 8 AWG ²⁾	
Torque	2.8 Nm 18 in.-lbs.	
Screwdriver	No. 2 Pozidrive	
Mounting	On DIN rail 35 mm acc. to EN 60715 by fast clip	
Mounting position	any	
Supply	optional	
Dimensions and weight		
Mounting dimensions acc. to DIN 43880	Mounting dimension 1	
Pole dimensions (H x D x W)	88 x 69 x 17.5	
Pole weight	approx. 115 g	
Combination with auxiliary elements		
Auxiliary contact	Yes	
Signal/auxiliary contact	Yes	
Shunt trip	Yes	
Undervoltage release	Yes	
Motor Operating Device	Yes	

¹⁾ AWG 18 – 4 acc. to UL 486A – 486B ²⁾ AWG 18 – 8 acc. to UL 486A – 486B

Tripping characteristics

Acc. to	Tripping characteristics	Rated current I_n	Thermal release ³⁾			Electromagnetic release ⁴⁾	
			Currents: conventional non-tripping current I_1	conventional tripping current I_2	Tripping time	Range of instantaneous tripping	Tripping time
IEC/EN 60898-1	B	6 to 63 A	$1.13 \cdot I_n$	$1.45 \cdot I_n$	> 1 h < 1 h ⁵⁾	$3 \cdot I_n$ $5 \cdot I_n$	0.1 ... 45 s ($I_n \leq 32$ A)/0.1 ... 90 s ($I_n > 32$ A) < 0.1 s
	C	0.5 to 63 A	$1.13 \cdot I_n$	$1.45 \cdot I_n$	> 1 h < 1 h ⁵⁾	$5 \cdot I_n$ $10 \cdot I_n$	0.1 ... 15 s ($I_n \leq 32$ A)/0.1 ... 30 s ($I_n > 32$ A) < 0.1 s
	D	0.5 to 63 A	$1.13 \cdot I_n$	$1.45 \cdot I_n$	> 1 h < 1 h ⁵⁾	$10 \cdot I_n$ $20 \cdot I_n$	0.1 ... 4 s ($I_n \leq 32$ A)/0.1 ... 8 s ($I_n > 32$ A) < 0.1 s
IEC/EN 60947-2	K	0.5 to 63 A	$1.05 \cdot I_n$	$1.2 \cdot I_n$	> 1 h < 1 h ⁵⁾	$10 \cdot I_n$ $14 \cdot I_n$	> 0.2 s < 0.2 s
	Z	0.5 to 63 A	$1.05 \cdot I_n$	$1.2 \cdot I_n$	> 1 h < 1 h ⁵⁾	$2 \cdot I_n$ $3 \cdot I_n$	> 0.2 s < 0.2 s

³⁾ The thermal releases are calibrated to a nominal reference ambient temperature; for B, C, D the reference value is 30 °C, for K and Z the reference value is 20 °C. In the case of higher ambient temperatures, the current values fall by approx. 6 % for each 10 K temperature rise.

⁴⁾ The indicated tripping values of electromagnetic tripping devices apply to a frequency of 50/60 Hz. The thermal release operates independent of frequency.

⁵⁾ As from operating temperature (after $I_1 > 1$ h)

Miniature Circuit Breaker S 200/S 200 M

Tripping characteristics

B characteristic

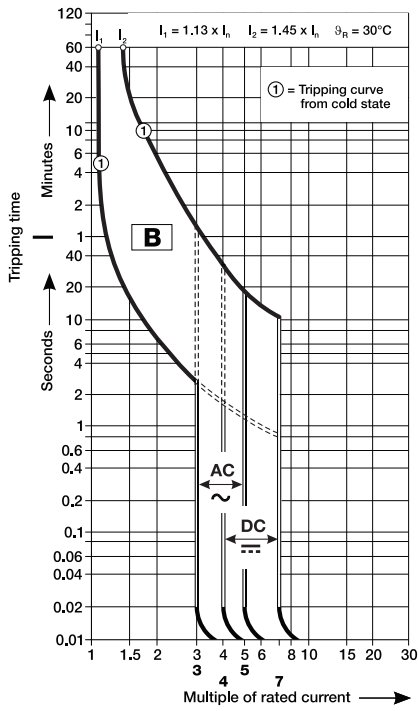

C characteristic

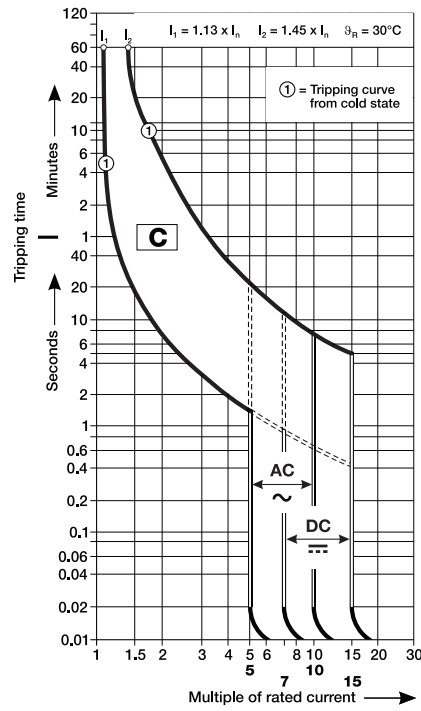

D characteristic

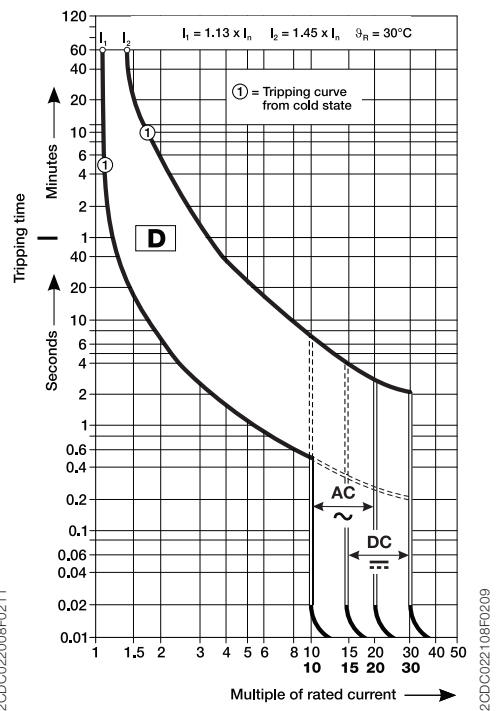

K characteristic

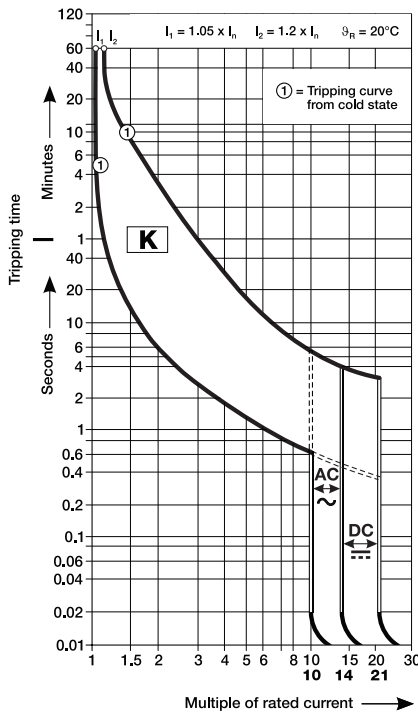

Z characteristic

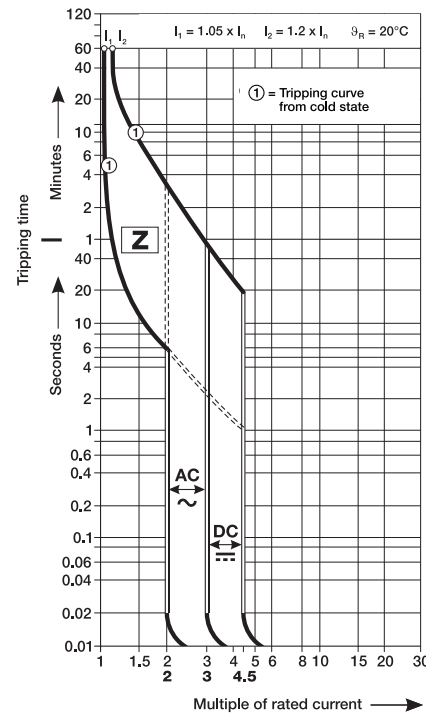

Miniature Circuit Breaker S 200/S 200 M

Derating

Deviating ambient temperature

For installations of miniature circuit breakers at other temperatures than the reference value derating factors have to be considered.

The rated value of the current of a miniature circuit breaker refers to a reference ambient temperature of 30 °C for circuit

breakers with the characteristics B, C and D and 20 °C for circuit breakers with the characteristics K and Z. The following table contains the derating of the load capability at ambient temperatures from -40 °C to 70 °C for the characteristics B, C, D, K and Z.

Tripping characteristics	Rated current I_n A	Maximum operating current at ambient temperature T											
		A	- 40 °C	- 30 °C	- 20 °C	- 10 °C	0 °C	10 °C	20 °C	30 °C	40 °C	50 °C	60 °C
B, C, D	0.5	0.67	0.65	0.62	0.60	0.58	0.55	0.53	0.50	0.47	0.44	0.41	0.37
	1.0	1.33	1.29	1.25	1.20	1.15	1.11	1.05	1.00	0.94	0.88	0.82	0.75
	1.6	2.13	2.07	2.00	1.92	1.85	1.77	1.69	1.60	1.51	1.41	1.31	1.19
	2.0	2.67	2.58	2.49	2.40	2.31	2.21	2.11	2.00	1.89	1.76	1.63	1.49
	3.0	4.0	3.9	3.7	3.6	3.5	3.3	3.2	3.0	2.8	2.6	2.4	2.2
	4.0	5.3	5.2	5.0	4.8	4.6	4.4	4.2	4.0	3.8	3.5	3.3	3.0
	6.0	8.0	7.7	7.5	7.2	6.9	6.6	6.3	6.0	5.7	5.3	4.9	4.5
	8.0	10.7	10.3	10.0	9.6	9.2	8.8	8.4	8.0	7.5	7.1	6.5	6.0
	10.0	13.3	12.9	12.5	12.0	11.5	11.1	10.5	10.0	9.4	8.8	8.2	7.5
	13.0	17.3	16.8	16.2	15.6	15.0	14.4	13.7	13.0	12.3	11.5	10.6	9.7
	16.0	21.3	20.7	20.0	19.2	18.5	17.7	16.9	16.0	15.1	14.1	13.1	11.9
	20.0	26.7	25.8	24.9	24.0	23.1	22.1	21.1	20.0	18.9	17.6	16.3	14.9
	25.0	33.3	32.3	31.2	30.0	28.9	27.6	26.4	25.0	23.6	22.0	20.4	18.6
	32.0	42.7	41.3	39.9	38.5	37.0	35.4	33.7	32.0	30.2	28.2	26.1	23.9
	40.0	53.3	51.6	49.9	48.1	46.2	44.2	42.2	40.0	37.7	35.3	32.7	29.8
50.0	66.7	64.5	62.4	60.1	57.7	55.3	52.7	50.0	47.1	44.1	40.8	37.3	
63.0	84.0	81.3	78.6	75.7	72.7	69.6	66.4	63.0	59.4	55.6	51.4	47.0	
K, Z	0.5	0.66	0.64	0.61	0.59	0.56	0.53	0.50	0.47	0.43	0.40	0.35	0.31
	1.0	1.32	1.27	1.22	1.17	1.12	1.06	1.00	0.94	0.87	0.79	0.71	0.61
	1.6	2.12	2.04	1.96	1.88	1.79	1.70	1.60	1.50	1.39	1.26	1.13	0.98
	2.0	2.65	2.55	2.45	2.35	2.24	2.12	2.00	1.87	1.73	1.58	1.41	1.22
	3.0	4.0	3.8	3.7	3.5	3.4	3.2	3.0	2.8	2.6	2.4	2.1	1.8
	4.0	5.3	5.1	4.9	4.7	4.5	4.2	4.0	3.7	3.5	3.2	2.8	2.4
	6.0	7.9	7.6	7.3	7.0	6.7	6.4	6.0	5.6	5.2	4.7	4.2	3.7
	8.0	10.8	10.2	9.8	9.4	8.9	8.5	8.0	7.5	6.9	6.3	5.7	4.9
	10.0	13.2	12.7	12.2	11.7	11.2	10.6	10.0	9.4	8.7	7.9	7.1	6.1
	13.0	17.2	16.6	15.9	15.2	14.5	13.8	13.0	12.2	11.3	10.3	9.2	8.0
	16.0	21.2	20.4	19.6	18.8	17.9	17.0	16.0	15.0	13.9	12.6	11.3	9.8
	20.0	26.5	25.5	24.5	23.5	22.4	21.2	20.0	18.7	17.3	15.8	14.1	12.2
	25.0	33.1	31.9	30.6	29.3	28.0	26.5	25.0	23.4	21.7	19.8	17.7	15.3
	32.0	42.3	40.8	39.2	37.5	35.8	33.9	32.0	29.9	27.7	25.3	22.6	19.6
	40.0	52.9	51.0	49.0	46.9	44.7	42.4	40.0	37.4	34.6	31.6	28.3	24.5
50.0	66.1	63.7	61.2	58.6	55.9	53.0	50.0	46.8	43.3	39.5	35.4	30.6	
63.0	83.3	80.3	77.2	73.9	70.4	66.8	63.0	58.9	54.6	49.8	44.5	38.6	

Influence of adjacent devices

If several miniature circuit breakers are installed directly side by side with high load on all poles, a correction factor has to be applied to the rated current (see table). If distance pieces are used, the factor is not to be considered.

No. of adjacent devices	Factor F
1	1
2, 3	0.9
4, 5	0.8
≥ 6	0.75

Example

Installation of 8 adjacent miniature circuit breakers S201-C16 at 40 °C ambient temperature

Rated current $I_n = 16$ A

Max. operating current at 40 °C = 15,1 A (see table above)

Factor F = 0.75 (see left table)

$I_n = 15.1 \text{ A} \times 0.75 = 11.33 \text{ A}$

Result: The operating current can only add up to max. 11.33 A

Miniature Circuit Breaker S 200/S 200 M

Internal resistance and power loss

Internal resistance and power loss per pole

Rated current I_n A	Tripping characteristic							
	B, C ¹⁾		D		K		Z	
	Internal resistance R_i mΩ	Power loss P_v W	Internal resistance R_i mΩ	Power loss P_v W	Internal resistance R_i mΩ	Power loss P_v W	Internal resistance R_i mΩ	Power loss P_v W
0.5	5500	1.4	4300	1.1	4300	1.1	8100	2.4
1.0	1440	1.4	1250	1.25	1250	1.25	2100	2.3
1.6	630	1.6	600	1.5	600	1.5	1000	2.8
2.0	460	1.8	410	1.6	410	1.65	619	2.5
3.0	150	1.3	130	1.2	130	1.2	235	2.4
4.0	110	1.8	105	1.7	105	1.7	149	2.4
6.0	55	2.0	52	1.9	52	1.9	75	3.2
8.0	23	1.5	24	1.5	24	1.5	27	2.0
10.0	19	2.1	16	1.6	13.5	1.4	24	2.7
13.0	14	2.3	14	2.2	13.5	1.4	—	—
16.0	8.5	2.5	8.5	2.5	7.7	2.0	10.9	2.8
20.0	6.25	2.5	6.1	2.3	6.7	2.7	6.0	2.4
25.0	5.0	3.2	4.3	3.1	4.6	2.9	4.5	3.3
32.0	3.6	3.7	3.5	3.6	3.5	3.6	3.5	3.6
40.0	3.0	4.8	2.2	4.2	2.2	4.2	2.5	4.1
50.0	1.3	3.25	1.25	2.9	1.25	3.1	1.5	4.1
63.0	1.2	4.8	1.2	4.8	1.0	4.4	1.3	5.2

¹⁾ Current ratings 0.5 – 4 A, 8 A apply to C characteristic only

Internal resistances are subject to application-specific and environment-specific conditions and are therefore to be considered as typical values.

Miniature Circuit Breaker S 200/S 200 M

Let-through energy I^2t

Characteristics B, C - 230/400 V let-through energy

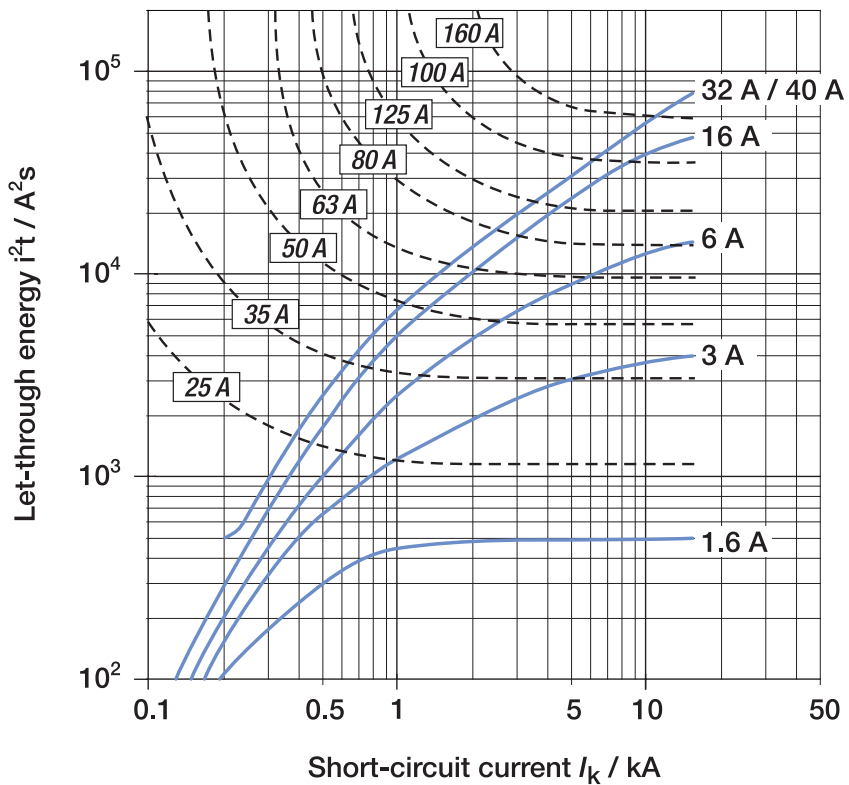
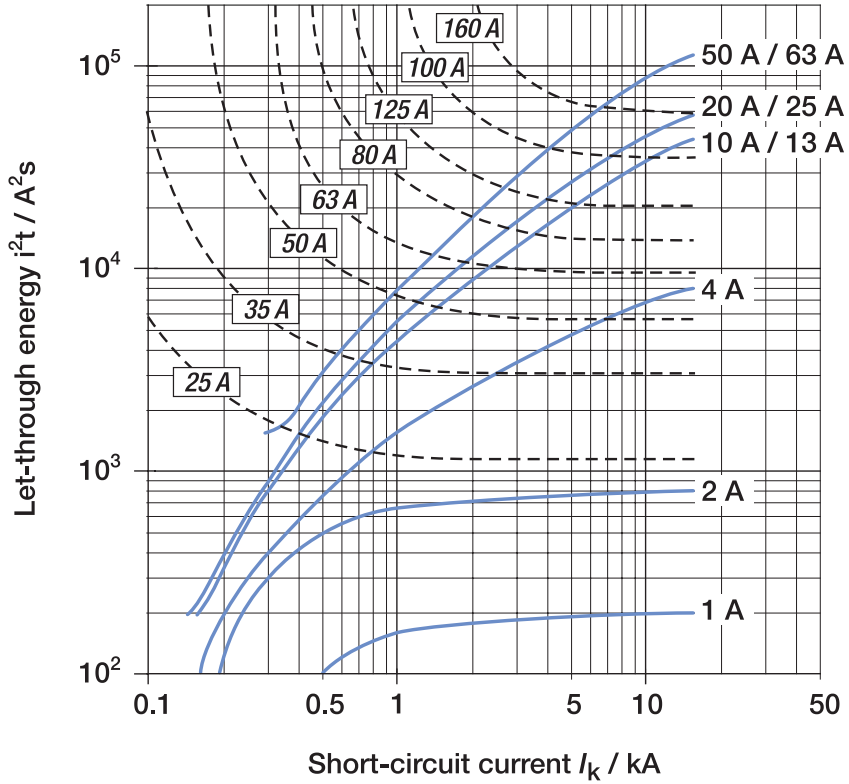

Miniature Circuit Breaker S 200/S 200 M

Let-through energy I^2t

Characteristics D, K - 230/400 V let-through energy

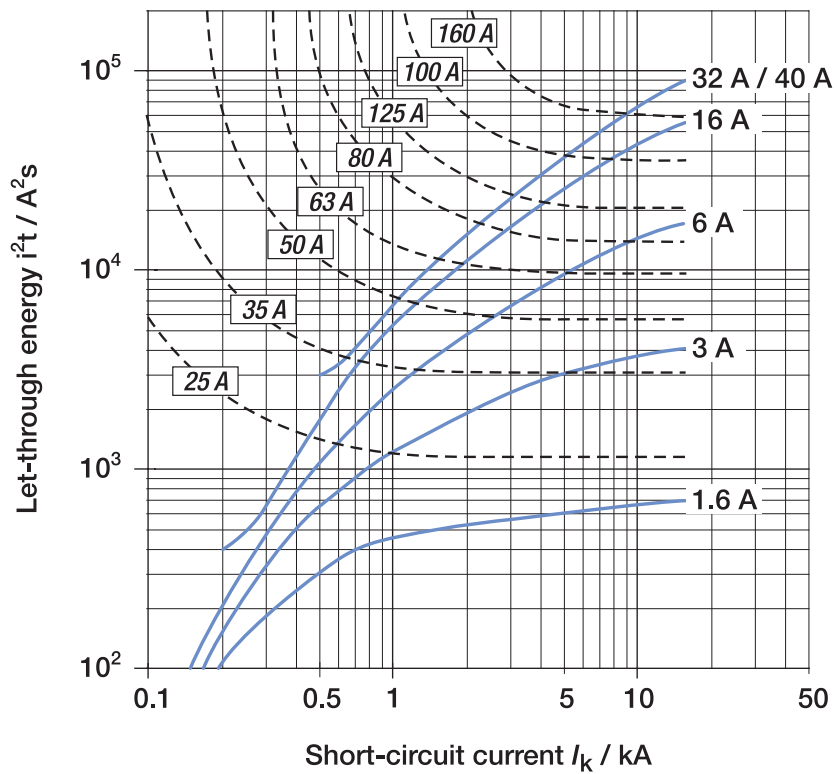
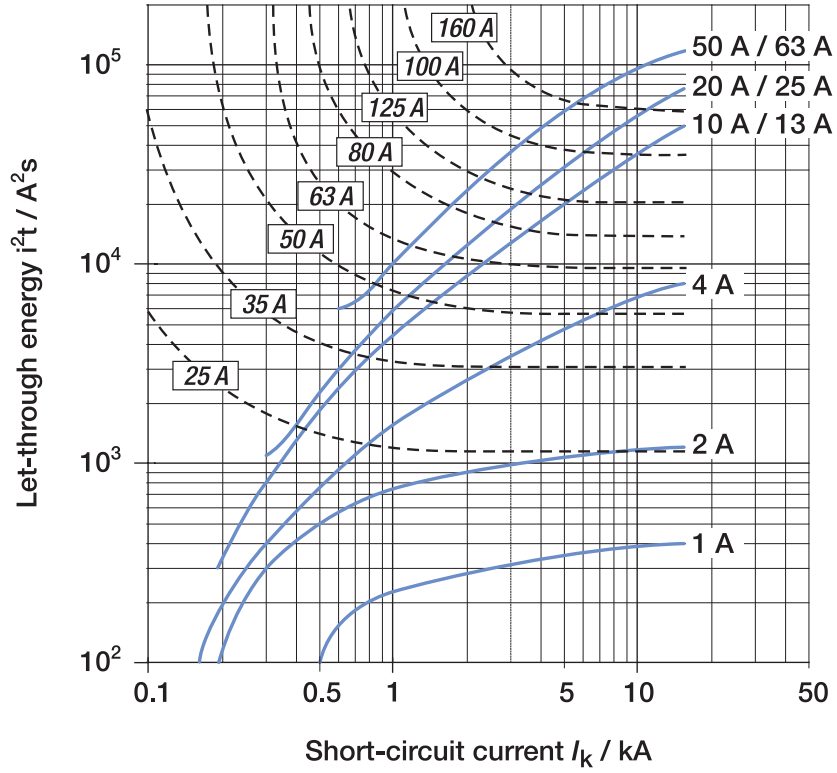

Miniature Circuit Breaker S 200/S 200 M

Let-through energy I^2t

Characteristic Z - 230/400 V let-through energy

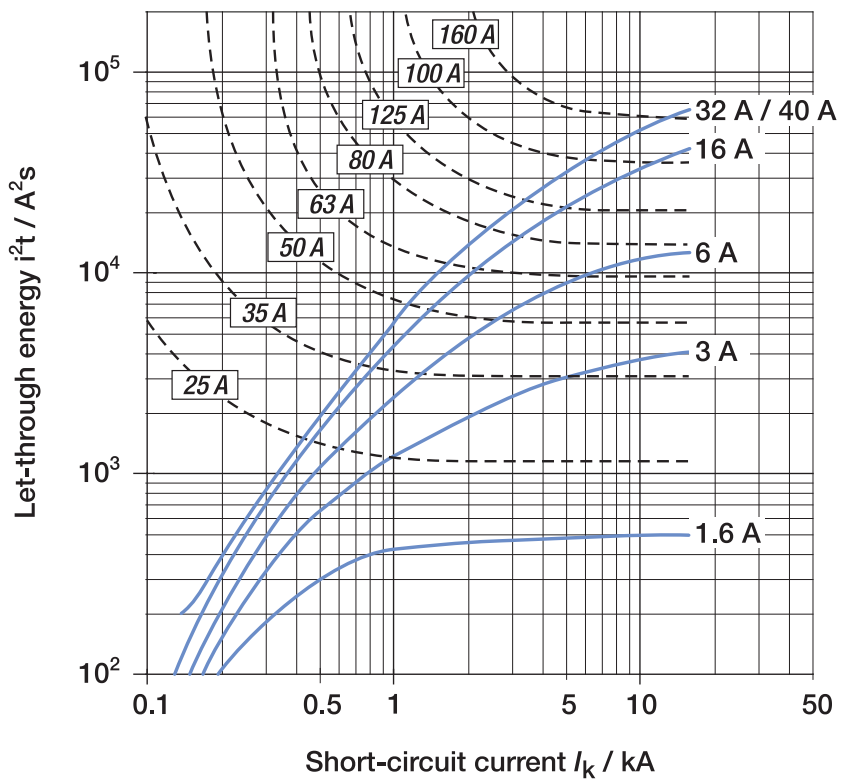
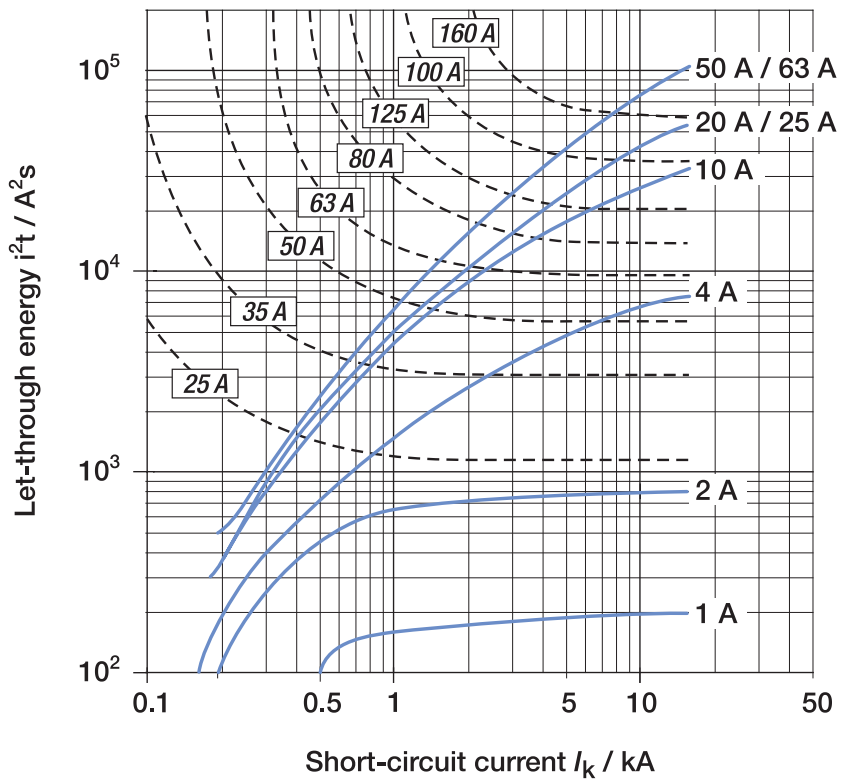

Miniature Circuit Breaker S 200/S 200 M

Accessories and dimensional drawing

Accessory overview

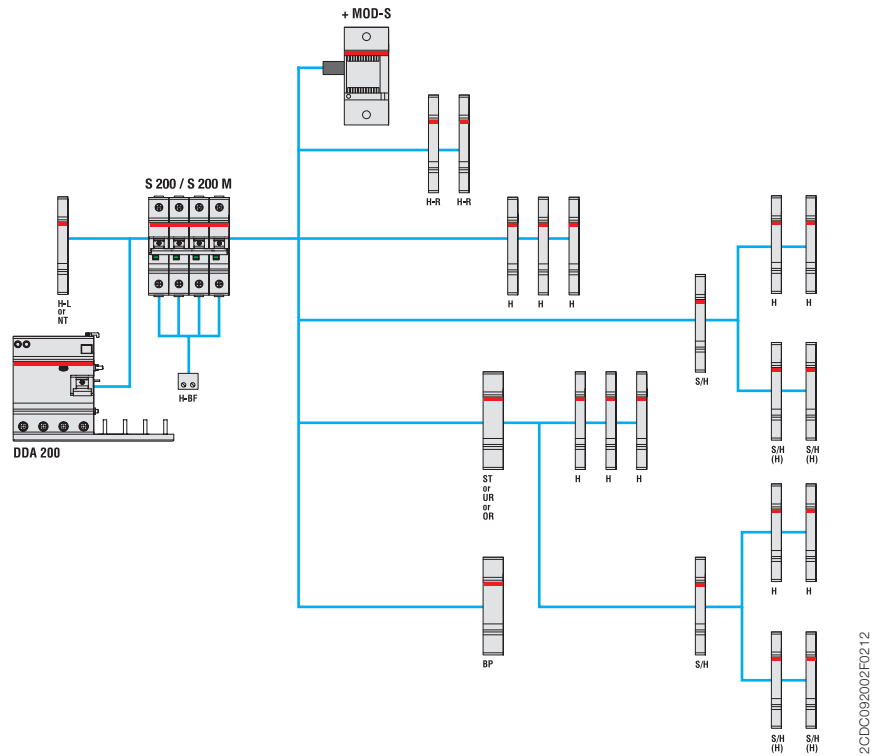

H	Auxiliary contact (change-over contact)	S2C-H6R	H-L	Auxiliary contact	S2C-H...L
H-R	Auxiliary contact	S2C-H6-...R	H-BF	Auxiliary contact for bottom fitting (1 per pole)	S2C-H01 S2C-H10
S/H	Signal/Auxiliary contact	S2C-S/H6R	BP	Mechanical tripping device	S2C-BP
S/H (H)	Signal/Auxiliary contact used as auxiliary contact	S2C-S/H6R	NT	Neutral disconnector	S2C-Nt
ST	Shunt trip	S2C-A...	MOD-S ¹⁾	Motor operating device	S2C-CM
UR	Undervoltage release	S2C-UA	DDA 200	RCD-block	DDA 20...
OR	Overvoltage release	S2C-OVP			





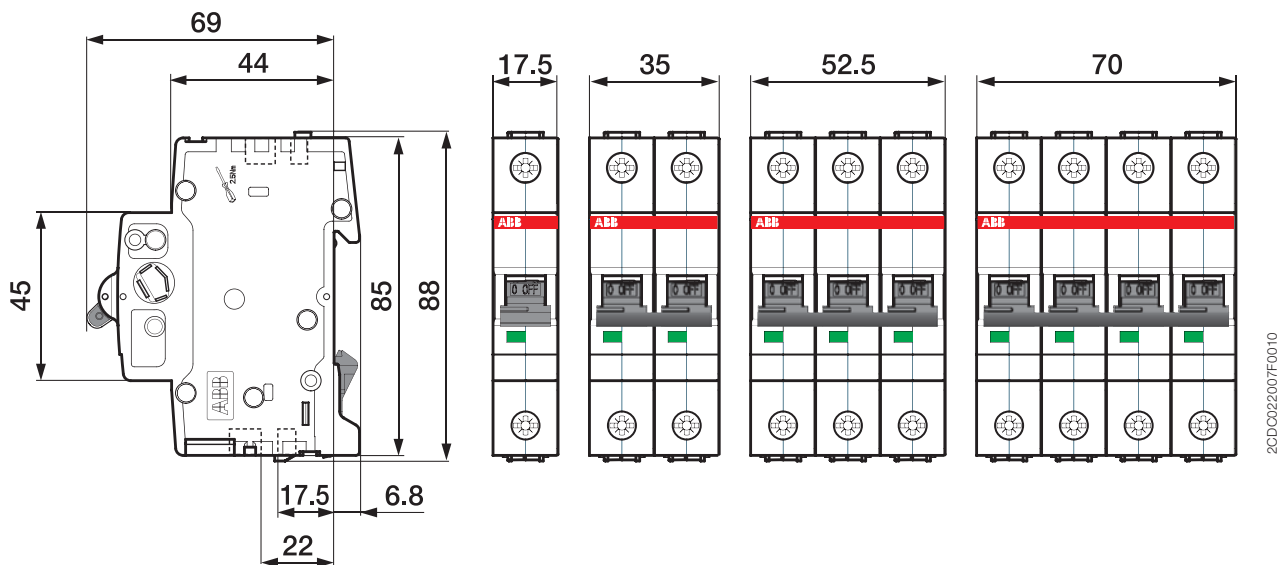



















¹⁾ In case of using S 200/S 200 M coupled with DDA 200, MOD-S does not operate in case of earth-leakage fault.

Dimensional drawing





Miniature Circuit Breaker S 200/S 200 M Approvals

Country approvals

Approval mark	Description	Country
	RCM	Australia
	ÖVE	Austria
	CEBEC	Belgium
	CSA	Canada (S 200 M only)
	CCC	China
	EZU	Czech Republic
	DEMKO	Denmark
	FIMKO	Finland
	NF	France
	VDE	Germany
	IMQ	Italy
	SIRIM	Malaysia
	KEMA	Netherlands
	NEMKO	Norway
	BBJ	Poland
	CERTIF	Portugal
	GOST	Russia
	GOST Fire	
	HDB	Singapore
	SIQ	Slovenia
	AENOR	Spain
	SEMKO	Sweden
	S+	Switzerland
	UL1077	USA

Ship approvals

Approval mark	Description	Country
	BV	France
	GL	Germany
	RINA	Italy
	ABS	USA

Not all approvals are printed on the MCBs.

The indicated approvals generally cover all available approvals worldwide. To verify the approval status in your country please get in touch with your ABB contact person.

Contact us

ABB STOTZ-KONTAKT GmbH

Eppelheimer Straße 82
69123 Heidelberg, Germany
Phone: +49 (0) 6221 7 01-0
Fax: +49 (0) 6221 7 01-13 25
E-Mail: info.desto@de.abb.com

You can find the address of your
local sales organization on the
ABB home page
<http://www.abb.com/contacts>
-> Low Voltage Products and Systems

Note:

We reserve the right to make technical changes or modify the contents of this document without prior notice. With regard to purchase orders, the agreed particulars shall prevail. ABB AG does not accept any responsibility whatsoever for potential errors or possible lack of information in this document.

We reserve all rights in this document and in the subject matter and illustrations contained therein. Any reproduction, disclosure to third parties or utilization of its contents – in whole or in parts – is forbidden without prior written consent of ABB AG.

Copyright© 2012 ABB
All rights reserved

Brochure number 2CDC002157D0202 (08/12-0.5-ZVD)